

SECTION **CHG**
CHARGING SYSTEM

A
B
C
D
E
F
G
H
I
J
K
L
N
O
P

CONTENTS

PRECAUTION	3	DTC/CIRCUIT DIAGNOSIS	20
PRECAUTIONS	3	CHARGING SYSTEM PRELIMINARY INSPECTION	20
Precaution for Supplemental Restraint System (SRS) "AIR BAG" and "SEAT BELT PRE-TENSIONER"	3	Diagnosis Procedure	20
Precaution for Power Generation Voltage Variable Control System	3	POWER GENERATION VOLTAGE VARIABLE CONTROL SYSTEM OPERATION INSPECTION	21
PREPARATION	4	Diagnosis Procedure	21
PREPARATION	4	B TERMINAL CIRCUIT	23
Special Service Tool	4	Description	23
Commercial Service Tool	4	Diagnosis Procedure	23
SYSTEM DESCRIPTION	5	L TERMINAL CIRCUIT (OPEN)	24
COMPONENT PARTS	5	Description	24
Component Parts Location	5	Diagnosis Procedure	24
Component Description	6	L TERMINAL CIRCUIT (SHORT)	26
SYSTEM	7	Description	26
CHARGING SYSTEM	7	Diagnosis Procedure	26
CHARGING SYSTEM : System Diagram	7	S TERMINAL CIRCUIT	27
CHARGING SYSTEM : System Description	7	Description	27
CHARGING SYSTEM : Component Description.....	7	Diagnosis Procedure	27
POWER GENERATION VOLTAGE VARIABLE CONTROL SYSTEM	8	SYMPTOM DIAGNOSIS	28
System Diagram	8	CHARGING SYSTEM	28
System Description	8	Symptom Table	28
WIRING DIAGRAM	9	REMOVAL AND INSTALLATION	29
CHARGING SYSTEM	9	GENERATOR	29
Wiring Diagram	9	Exploded View	29
BASIC INSPECTION	14	Removal and Installation	29
DIAGNOSIS AND REPAIR WORKFLOW	14	SERVICE DATA AND SPECIFICATIONS (SDS)	31
Work Flow (With EXP-800 NI or GR8-1200 NI)	14		
Work Flow (Without EXP-800 NI or GR8-1200 NI)... ..	17		

CHG

SERVICE DATA AND SPECIFICATIONS
(SDS) 31

Generator 31

PRECAUTIONS

< PRECAUTION >

PRECAUTION

PRECAUTIONS

Precaution for Supplemental Restraint System (SRS) "AIR BAG" and "SEAT BELT PRE-TENSIONER"

INFOID:000000012431235

The Supplemental Restraint System such as "AIR BAG" and "SEAT BELT PRE-TENSIONER", used along with a front seat belt, helps to reduce the risk or severity of injury to the driver and front passenger for certain types of collision. Information necessary to service the system safely is included in the SR and SB section of this Service Manual.

WARNING:

- To avoid rendering the SRS inoperative, which could increase the risk of personal injury or death in the event of a collision which would result in air bag inflation, all maintenance must be performed by an authorized NISSAN/INFINITI dealer.
- Improper maintenance, including incorrect removal and installation of the SRS, can lead to personal injury caused by unintentional activation of the system. For removal of Spiral Cable and Air Bag Module, see the SR section.
- Do not use electrical test equipment on any circuit related to the SRS unless instructed to in this Service Manual. SRS wiring harnesses can be identified by yellow and/or orange harnesses or harness connectors.

PRECAUTIONS WHEN USING POWER TOOLS (AIR OR ELECTRIC) AND HAMMERS

WARNING:

- When working near the Airbag Diagnosis Sensor Unit or other Airbag System sensors with the Ignition ON or engine running, DO NOT use air or electric power tools or strike near the sensor(s) with a hammer. Heavy vibration could activate the sensor(s) and deploy the air bag(s), possibly causing serious injury.
- When using air or electric power tools or hammers, always switch the Ignition OFF, disconnect the battery and wait at least three minutes before performing any service.

Precaution for Power Generation Voltage Variable Control System

INFOID:000000012431236

CAUTION:

For model with power generation voltage variable control system, the battery current sensor that is installed to the battery cable at the negative terminal measures the charging/discharging current of the battery, and performs various controls. If the electrical component or the ground wire is connected directly to the battery terminal, the current other than that being measured with the battery current sensor is charging to or discharging from the battery. This condition causes the malfunction of the control, and then the battery discharge may occur. Do not connect the electrical component or the ground wire directly to the battery terminal.

A
B
C
D
E
F
G
H
I
J
K
L
N
O
P

CHG

PREPARATION

< PREPARATION >

PREPARATION

PREPARATION

Special Service Tool

INFOID:000000012431237

The actual shape of the tools may differ from those illustrated here.

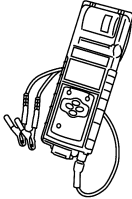
Tool number (TechMate No.) Tool name	Description
<p>— (—) Model GR8-1200 NI Multitasking battery and electrical diagnostic station</p>  <p style="text-align: right; font-size: small;">AWI1A1239ZZ</p>	<p>Tests batteries, starting and charging systems and charges batteries. Operating instructions, refer to diagnostic station instruction manual.</p>
<p>— (—) Model EXP-800 NI Battery and electrical diagnostic analyzer</p>  <p style="text-align: right; font-size: small;">JSMIA0806ZZ</p>	<p>Tests batteries and charging systems. Operating instructions, refer to diagnostic analyzer instruction manual.</p>

Commercial Service Tool

INFOID:000000012431238

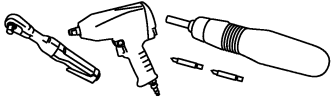
Tool name	Description
<p>Power tool</p>  <p style="text-align: right; font-size: small;">PIIB1407E</p>	<p>Loosening nuts, screws and bolts</p>

COMPONENT PARTS

< SYSTEM DESCRIPTION >

SYSTEM DESCRIPTION

COMPONENT PARTS

Component Parts Location

INFOID:0000000012431239

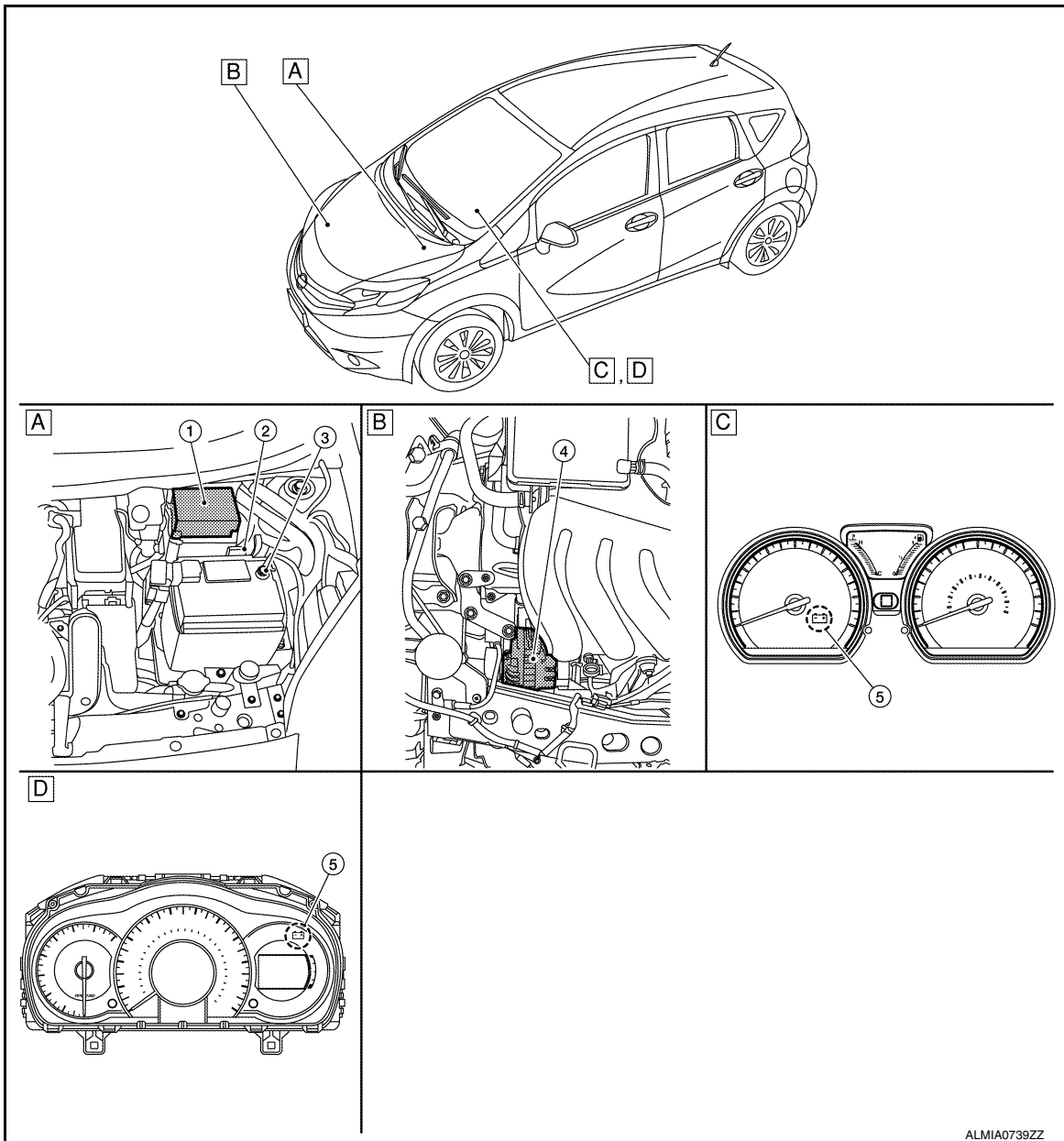

- A. Engine room LH (view with air duct inlet removed)
- D. Combination meter (type B)

B. Engine room RH

C. Combination meter (type A)

COMPONENT PARTS

< SYSTEM DESCRIPTION >

Component Description

INFOID:000000012431240

No.	Component part	Description
1	IPDM E/R	The IPDM E/R converts the received power generation command value into a pulse width modulated (PWM) command signal and sends it to the IC regulator.
2	ECM	<p>The battery current sensor detects the charging/discharging current of the battery. The ECM judges the battery condition based on this signal.</p> <p>The ECM judges whether to request more output via the power generation voltage variable control according to the battery condition.</p> <p>When performing the power generation voltage variable control, the ECM calculates the target power generation voltage according to the battery condition and sends the calculated value as the power generation command value to the IPDM E/R.</p>
3	Battery current sensor	The battery current sensor is located on the negative battery cable terminal. The battery current sensor detects the charging/discharging current of the battery and sends a voltage signal to the ECM according to the current value detected.
4	Generator (IC regulator)	<p>The IC regulator controls the power generation voltage by the target power generation voltage based on the received PWM command signal.</p> <p>When there is no PWM command signal, the generator performs the normal power generation according to the characteristic of the IC regulator.</p>
5	Combination meter (charge warning lamp)	<p>The IC regulator warning function activates to illuminate the charge warning lamp if any of the following symptoms occur while generator is operating:</p> <ul style="list-style-type: none">• Excessive voltage is produced.• No voltage is produced.

SYSTEM

< SYSTEM DESCRIPTION >

SYSTEM

CHARGING SYSTEM

CHARGING SYSTEM : System Diagram

INFOID:000000012431241

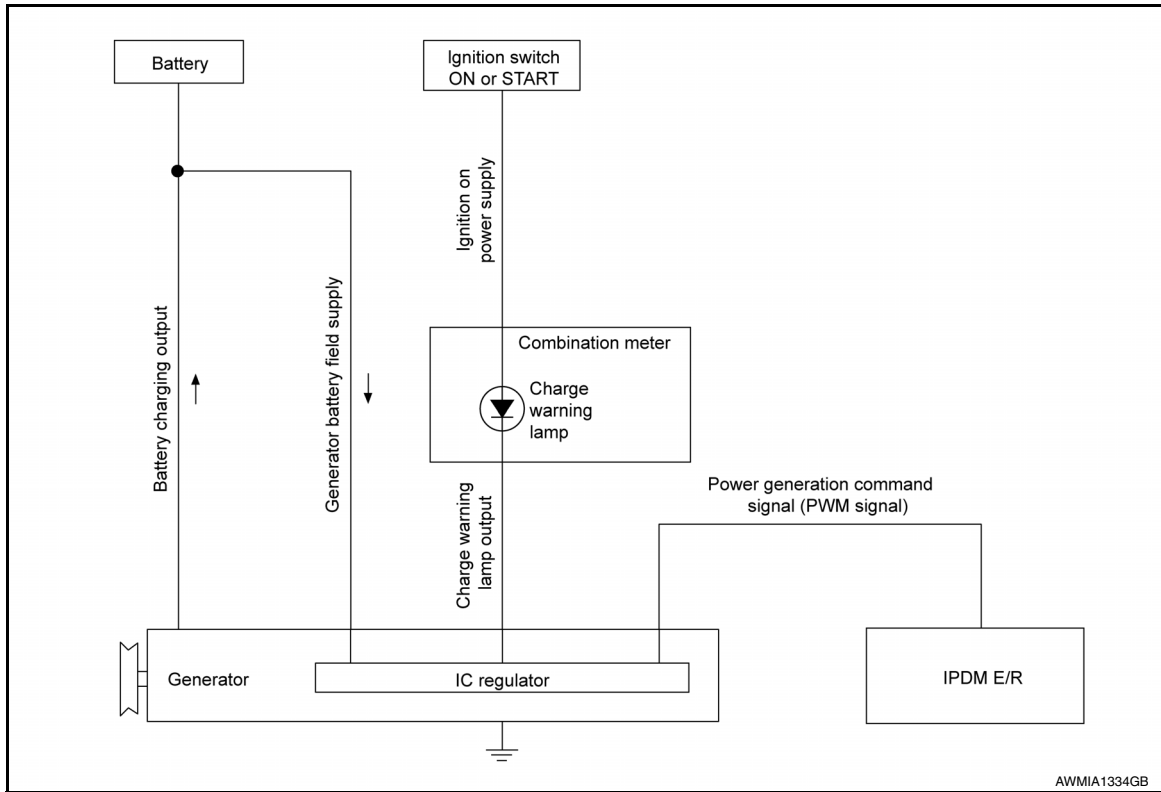

CHARGING SYSTEM : System Description

INFOID:000000012431242

The generator provides DC voltage to operate the vehicle's electrical system and to keep the battery charged. The voltage output is controlled by the IC regulator.

CHARGING SYSTEM : Component Description

INFOID:000000012431243

Component part		Description
Generator	Terminal "1"	Refer to CHG-23, "Description" .
	Terminal "2"	Refer to CHG-24, "Description" .
	Terminal "3"	Refer to CHG-27, "Description" .
	Terminal "4"	Used for the power generation voltage variable control system. Refer to CHG-8, "System Description" .
Combination meter (Charge warning lamp)		The IC regulator warning function activates to illuminate the charge warning lamp if any of the following symptoms occur while generator is operating: <ul style="list-style-type: none"> Excessive voltage is produced. No voltage is produced.
IPDM E/R		Used for the power generation voltage variable control system. Refer to CHG-8, "System Description" .

POWER GENERATION VOLTAGE VARIABLE CONTROL SYSTEM

< SYSTEM DESCRIPTION >

POWER GENERATION VOLTAGE VARIABLE CONTROL SYSTEM

System Diagram

INFOID:000000012431244

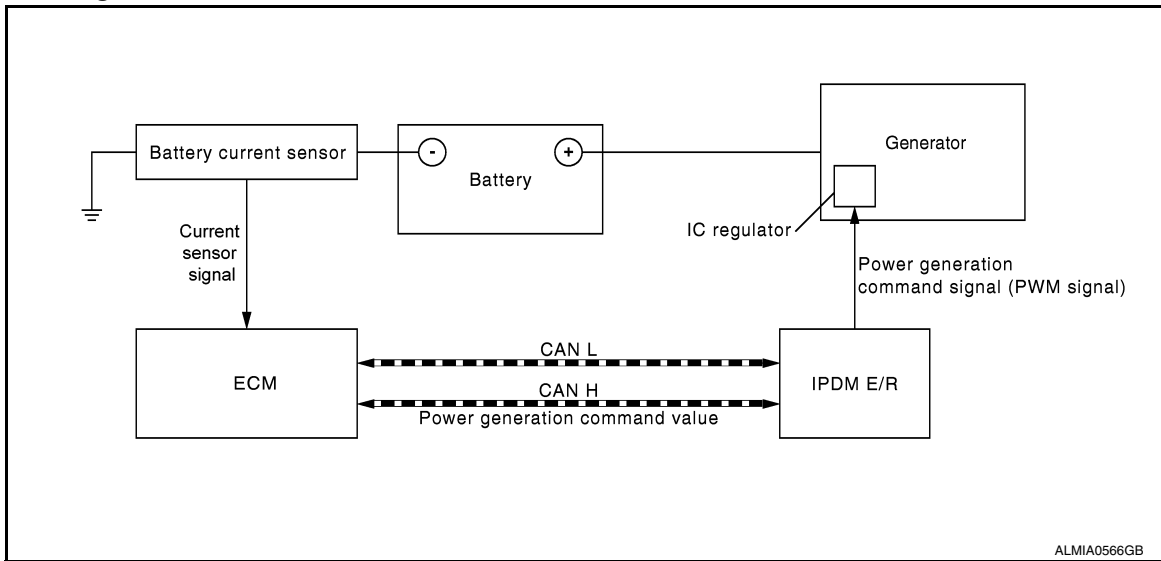

System Description

INFOID:000000012431245

Power generation variable voltage control system has been adopted. By varying the voltage to the generator, engine load due to power generation of the generator is reduced and fuel consumption is decreased.

NOTE:

When any malfunction is detected in the power generation variable voltage control system, power generation is performed according to the characteristic of the IC regulator in the generator.

CHARGING SYSTEM

< WIRING DIAGRAM >

CHARGING SYSTEM CONNECTORS

Connector No.	M24
Connector Name	COMBINATION METER (WITH TYPE B)
Connector Color	WHITE



20	19	18	17	16	15	14	13	12	11	10	9	8	7	6	5	4	3	2	1
40	39	38	37	36	35	34	33	32	31	30	29	28	27	26	25	24	23	22	21

Terminal No.	Color of Wire	Signal Name
28	GR	IGN
38	Y	CHARGE SIGNAL W/BRAKE BULB CHECK

Connector No.	M69
Connector Name	WIRE TO WIRE
Connector Color	WHITE

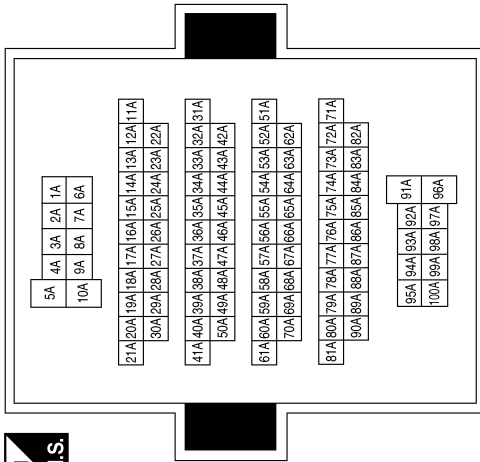

Terminal No.	Color of Wire	Signal Name
17A	Y	—

Connector No.	M82
Connector Name	COMBINATION METER (WITH TYPE A)
Connector Color	WHITE



20	19	18	17	16	15	14	13	12	11	10	9	8	7	6	5	4	3	2	1
40	39	38	37	36	35	34	33	32	31	30	29	28	27	26	25	24	23	22	21

Terminal No.	Color of Wire	Signal Name
28	GR	IGN
38	Y	CHG

CHARGING SYSTEM

< WIRING DIAGRAM >

Connector No.	E8
Connector Name	WIRE TO WIRE
Connector Color	WHITE

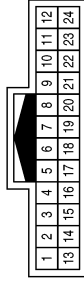

Terminal No.	19	Color of Wire	V	Signal Name	-
--------------	----	---------------	---	-------------	---

Terminal No.	17A	Color of Wire	V	Signal Name	-
--------------	-----	---------------	---	-------------	---

Connector No.	E7
Connector Name	WIRE TO WIRE
Connector Color	WHITE

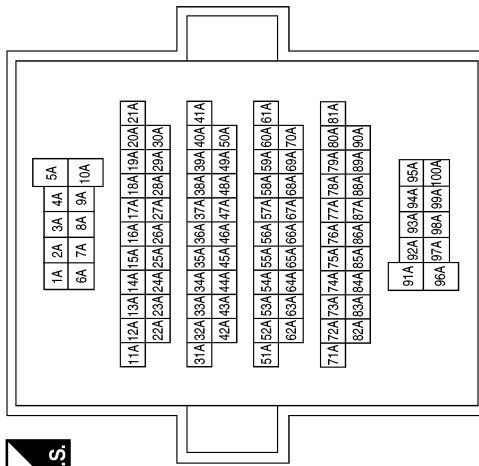

Connector No.	E19
Connector Name	WIRE TO WIRE
Connector Color	WHITE



Terminal No.	2	Color of Wire	L	Signal Name	-
--------------	---	---------------	---	-------------	---

Connector No.	E16
Connector Name	ECM
Connector Color	BLACK

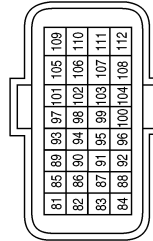

Terminal No.	83	Color of Wire	P	Signal Name	CAN-L
Terminal No.	84	Color of Wire	L	Signal Name	CAN-H

Connector No.	E14
Connector Name	JOINT CONNECTOR-E03
Connector Color	BLUE

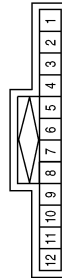

Terminal No.	1	Color of Wire	P	Signal Name	-
Terminal No.	4	Color of Wire	P	Signal Name	-
Terminal No.	8	Color of Wire	L	Signal Name	-
Terminal No.	11	Color of Wire	L	Signal Name	-

AAMIA2732GB



A
B
C
D
E
F
G
H
I
J
K
L
N
O
P

CHG

CHARGING SYSTEM

< WIRING DIAGRAM >

Connector No.	E46
Connector Name	IPDM E/R (INTELLIGENT POWER DISTRIBUTION MODULE ENGINE ROOM)
Connector Color	WHITE

Terminal No.	Color of Wire	Signal Name
60	B	SIGNAL-GND
61	P	CAN-L
62	L	CAN-H

Connector No.	F1
Connector Name	GENERATOR
Connector Color	BLACK





Terminal No.	Color of Wire	Signal Name
2	L/W	-
3	G	-
4	O	-

Connector No.	F2
Connector Name	GENERATOR
Connector Color	-



Terminal No.	Color of Wire	Signal Name
1	B/R	-

Connector No.	F4
Connector Name	GENERATOR
Connector Color	-

Terminal No.	Color of Wire	Signal Name
5	B/Y	-

Connector No.	F8
Connector Name	WIRE TO WIRE
Connector Color	WHITE



Terminal No.	Color of Wire	Signal Name
19	L/W	-

Connector No.	F9
Connector Name	BATTERY CURRENT SENSOR
Connector Color	GRAY

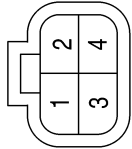



Terminal No.	Color of Wire	Signal Name
1	Y	-
2	L	-
3	R	-
4	BR	-

CHARGING SYSTEM

< WIRING DIAGRAM >

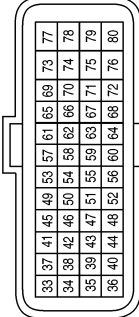
Connector No.	F11
Connector Name	ECM
Connector Color	BROWN



Terminal No.	Color of Wire	Signal Name
39	L	BATTERY TEMPERATURE SENSOR
58	BR	BATTERY CURRENT SENSOR
68	R	SENSOR GROUND (BATTERY CURRENT SENSOR)
71	Y	SENSOR POWER SUPPLY (BATTERY CURRENT SENSOR)

Connector No.	F33
Connector Name	WIRE TO WIRE
Connector Color	WHITE





Terminal No.	Color of Wire	Signal Name
2	G	-

Connector No.	F40
Connector Name	FUSIBLE LINK BOX (BATTERY)
Connector Color	-

Connector No.	F43
Connector Name	IPDM E/R (INTELLIGENT POWER DISTRIBUTION MODULE ENGINE ROOM)
Connector Color	WHITE

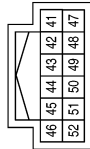
Terminal No.	Color of Wire	Signal Name
5	B/R	-

Terminal No.	Color of Wire	Signal Name
48	O	ALT C

AAMIA2745GB

A
B
C
D
E
F
G
H
I
J
K
L
N
O
P

CHG

DIAGNOSIS AND REPAIR WORKFLOW

< BASIC INSPECTION >

BASIC INSPECTION

DIAGNOSIS AND REPAIR WORKFLOW

Work Flow (With EXP-800 NI or GR8-1200 NI)

INFOID:0000000012431247

CHARGING SYSTEM DIAGNOSIS WITH EXP-800 NI OR GR8-1200 NI

To test the charging system, use the following special service tools:

- EXP-800 NI Battery and electrical diagnostic analyzer
- GR8-1200 NI Multitasking battery and electrical diagnostic station

NOTE:

Refer to the applicable Instruction Manual for proper charging system diagnosis procedures.

DIAGNOSIS AND REPAIR WORKFLOW

< BASIC INSPECTION >

OVERALL SEQUENCE

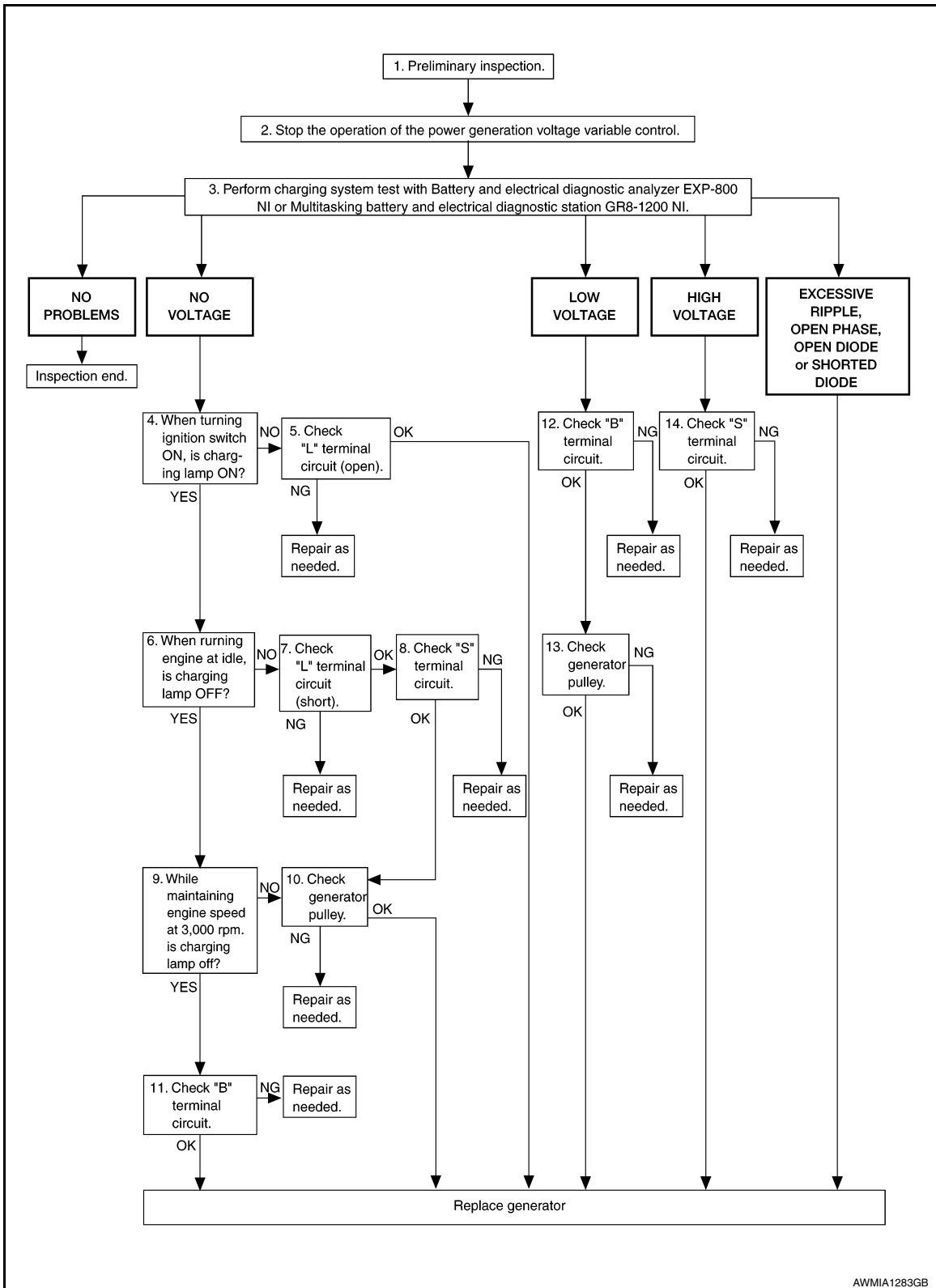

DETAILED FLOW

NOTE:

To ensure a complete and thorough diagnosis, the battery, stator and generator test segments must be done as a set from start to finish.

1. PRELIMINARY INSPECTION

Perform the preliminary inspection. Refer to [CHG-20. "Diagnosis Procedure"](#).

A
B
C
D
E
F
G
H
I
J
K
L
CHG
N
O
P

DIAGNOSIS AND REPAIR WORKFLOW

< BASIC INSPECTION >

>> GO TO 2.

2. STOP POWER GENERATION VOLTAGE VARIABLE CONTROL SYSTEM

Stop the operation of the power generation voltage variable control in either of the following procedures.

- After selecting “ENGINE” using CONSULT, set the DUTY value of “ALTERNATOR DUTY” to 0 % by selecting “ALTERNATOR DUTY” of “Active Test”. Continue “Active Test” until the end of inspection. (When the DUTY value is 0 or 100 %, the normal power generation is performed according to the characteristic of the IC regulator of the generator.)
- Turn the ignition switch OFF, and disconnect the battery current sensor connector. [However, DTC (P1550–P1554) of the engine might remain. After finishing the inspection, connect the battery current sensor connector and erase the self diagnosis results history of the engine using CONSULT.]

>> GO TO 3.

3. DIAGNOSIS WITH EXP-800 NI OR GR8-1200 NI

Perform the charging system test using Multitasking battery and electrical diagnostic station GR8-1200 NI or Battery and electrical diagnostic analyzer EXP-800 NI. Refer to the applicable Instruction Manual for proper testing procedures.

Test result

NO PROBLEMS>>Charging system is normal and will also show “DIODE RIPPLE” test result.

NO VOLTAGE>>GO TO 4.

LOW VOLTAGE>>GO TO 12.

HIGH VOLTAGE>>GO TO 14.

EXCESSIVE RIPPLE, OPEN PHASE, OPEN DIODE or SHORTED DIODE>>Replace the generator. Refer to [CHG-29, "Removal and Installation"](#). Perform “DIODE RIPPLE” test again using Multitasking battery and electrical diagnostic station GR8-1200 NI or Battery and electrical diagnostic analyzer EXP-800 NI to confirm repair.

4. INSPECTION WITH CHARGE WARNING LAMP (IGNITION SWITCH IS ON)

Turn the ignition switch ON.

Does the charge warning lamp illuminate?

YES >> GO TO 6.

NO >> GO TO 5.

5. “L” TERMINAL CIRCUIT (OPEN) INSPECTION

Check “L” terminal circuit (open). Refer to [CHG-24, "Diagnosis Procedure"](#).

Is the “L” terminal circuit normal?

YES >> Replace generator. Refer to [CHG-29, "Removal and Installation"](#).

NO >> Repair as needed.

6. INSPECTION WITH CHARGE WARNING LAMP (IDLING)

Start the engine and run it at idle.

Does the charge warning lamp turn OFF?

YES >> GO TO 9.

NO >> GO TO 7.

7. “L” TERMINAL CIRCUIT (SHORT) INSPECTION

Check “L” terminal circuit (short). Refer to [CHG-26, "Diagnosis Procedure"](#).

Is the “L” terminal circuit normal?

YES >> GO TO 8.

NO >> Repair as needed.

8. “S” TERMINAL CIRCUIT INSPECTION

Check “S” terminal circuit. Refer to [CHG-27, "Diagnosis Procedure"](#).

Is the “S” terminal circuit normal?

YES >> GO TO 10.

DIAGNOSIS AND REPAIR WORKFLOW

< BASIC INSPECTION >

NO >> Repair as needed.

9. INSPECTION WITH CHARGE WARNING LAMP (ENGINE AT 3,000 RPM)

Increase and maintain the engine speed at 3,000 rpm.

Does the charge warning lamp remain off?

YES >> GO TO 11.

NO >> GO TO 10.

10. INSPECTION OF GENERATOR PULLEY

Check generator pulley. Refer to [CHG-29. "Removal and Installation"](#).

Is generator pulley normal?

YES >> Replace generator. Refer to [CHG-29. "Removal and Installation"](#).

NO >> Repair as needed.

11. "B" TERMINAL CIRCUIT INSPECTION

Check "B" terminal circuit. Refer to [CHG-23. "Diagnosis Procedure"](#).

Is "B" terminal circuit normal?

YES >> Replace generator. Refer to [CHG-29. "Removal and Installation"](#).

NO >> Repair as needed.

12. "B" TERMINAL CIRCUIT INSPECTION

Check "B" terminal circuit. Refer to [CHG-23. "Diagnosis Procedure"](#).

Is "B" terminal circuit normal?

YES >> GO TO 13.

NO >> Repair as needed.

13. INSPECTION OF GENERATOR PULLEY

Check generator pulley. Refer to [CHG-29. "Removal and Installation"](#).

Is generator pulley normal?

YES >> Replace generator. Refer to [CHG-29. "Removal and Installation"](#).

NO >> Repair as needed.

14. "S" TERMINAL CIRCUIT INSPECTION

Check "S" terminal circuit. Refer to [CHG-27. "Diagnosis Procedure"](#).

Is the "S" terminal circuit normal?

YES >> Replace generator. Refer to [CHG-29. "Removal and Installation"](#).

NO >> Repair as needed.

Work Flow (Without EXP-800 NI or GR8-1200 NI)

INFOID:000000012431248

OVERALL SEQUENCE

Before performing a generator test, make sure that the battery is fully charged. A 30-volt voltmeter and suitable test probes are necessary for the test.

- Before starting, inspect the fusible link.

A
B
C
D
E
F
G
H
I
J
K
L
N
O
P

CHG

DIAGNOSIS AND REPAIR WORKFLOW

< BASIC INSPECTION >

- Use fully charged battery.

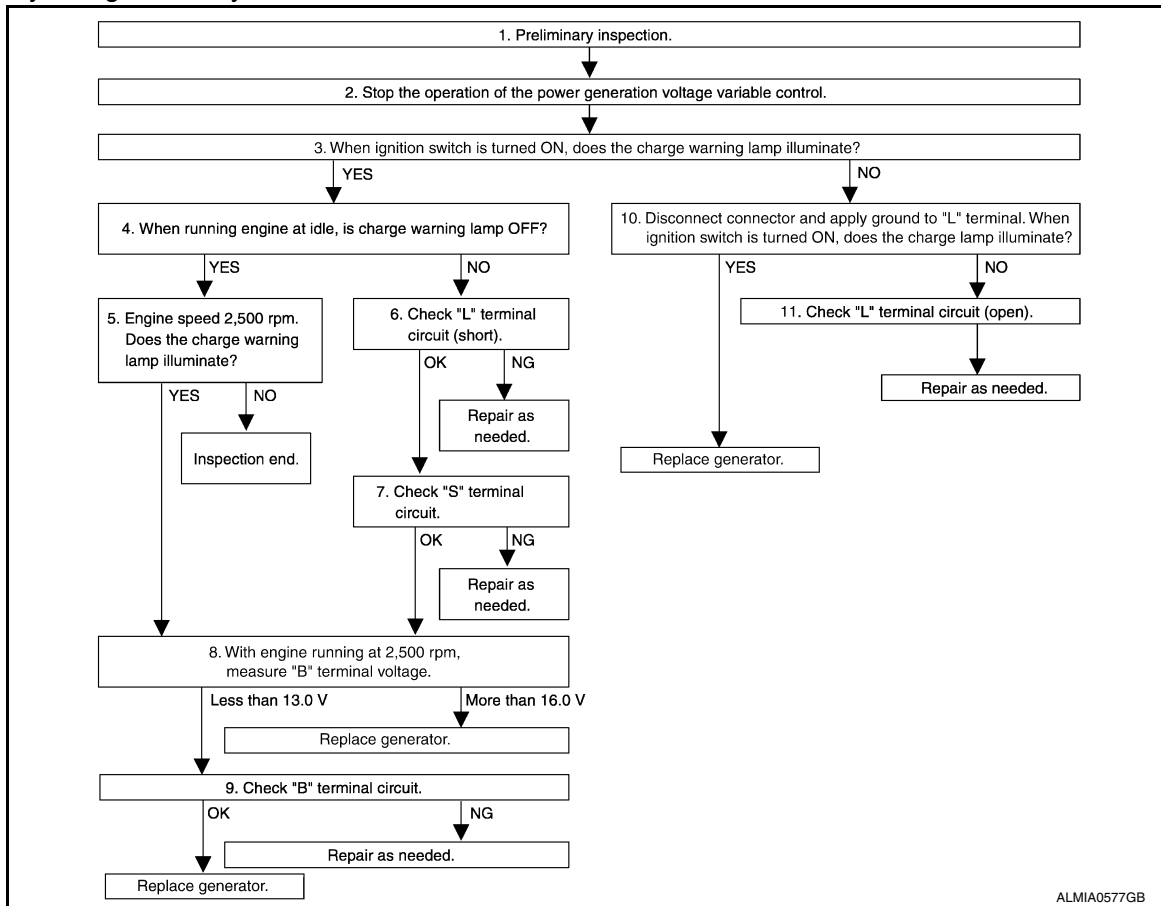

ALMIA0577GB

DETAILED FLOW

1. PRELIMINARY INSPECTION

Perform the preliminary inspection. Refer to [CHG-20, "Diagnosis Procedure"](#).

>> GO TO 2.

2. STOP POWER GENERATION VOLTAGE VARIABLE CONTROL SYSTEM

Stop the operation of the power generation voltage variable control in either of the following procedures:

- After selecting "ENGINE" using CONSULT, set the DUTY value of "ALTERNATOR DUTY" to 0 % by selecting "ALTERNATOR DUTY" with "Active Test". Continue "Active Test" until the end of inspection. (When the DUTY value is 0 or 100 %, the normal power generation is performed according to the characteristic of the IC regulator of the generator.)
- Turn the ignition switch OFF, and disconnect the battery current sensor connector. [However, DTC (P1550 - P1554) of the engine might remain. After finishing the inspection, connect the battery current sensor connector and erase the self-diagnostic results history of the engine using CONSULT.]

>> GO TO 3.

3. INSPECTION WITH CHARGE WARNING LAMP (IGNITION SWITCH IS TURNED ON)

When ignition switch is turned ON.

Does the charge warning lamp illuminate?

YES >> GO TO 4.

NO >> GO TO 10.

4. INSPECTION WITH CHARGE WARNING LAMP (IDLING)

Start the engine and run it at idle

Does the charge warning lamp turn OFF?

DIAGNOSIS AND REPAIR WORKFLOW

< BASIC INSPECTION >

YES >> GO TO 5.
NO >> GO TO 6.

5.INSPECTION WITH CHARGE WARNING LAMP (ENGINE AT 2,500 RPM)

Increase and maintain the engine speed at 2,500 rpm.

Does the charge warning lamp illuminate?

YES >> GO TO 8.
NO >> Inspection End.

6.“L” TERMINAL CIRCUIT (SHORT) INSPECTION

Check terminal “L” circuit for (short). Refer to [CHG-26. "Diagnosis Procedure"](#).

Is the inspection result normal?

YES >> GO TO 7.
NO >> Repair as needed.

7.“S” TERMINAL CIRCUIT INSPECTION

Check terminal “S” circuit. Refer to [CHG-27. "Diagnosis Procedure"](#).

Is the inspection result normal?

YES >> GO TO 8.
NO >> Repair as needed.

8.MEASURE “B” TERMINAL VOLTAGE

Start engine. With engine running at 2,500 rpm, measure “B” terminal voltage.

What voltage does the measurement result show?

Less than 13.0 V>>GO TO 9.
More than 16.0 V>>Replace generator. Refer to [CHG-29. "Removal and Installation"](#).

9.“B” TERMINAL CIRCUIT INSPECTION

Check “B” terminal circuit. Refer to [CHG-23. "Diagnosis Procedure"](#).

Is the inspection result normal?

YES >> Replace generator. Refer to [CHG-29. "Removal and Installation"](#).
NO >> Repair as needed.

10.INSPECTION WITH CHARGE WARNING LAMP (IGNITION SWITCH IS ON)

1. Disconnect generator connector and apply ground to “L” terminal.
2. Turn the ignition switch ON.

Does the charge warning lamp illuminate?

YES >> Replace generator. Refer to [CHG-29. "Removal and Installation"](#).
NO >> GO TO 11.

11.CHECK “L” TERMINAL CIRCUIT (OPEN)

Check “L” terminal circuit (OPEN). Refer to [CHG-24. "Diagnosis Procedure"](#).

>> Repair as needed.

A
B
C
D
E
F
G
H
I
J
K
L
N
O
P

CHG

CHARGING SYSTEM PRELIMINARY INSPECTION

< DTC/CIRCUIT DIAGNOSIS >

DTC/CIRCUIT DIAGNOSIS

CHARGING SYSTEM PRELIMINARY INSPECTION

Diagnosis Procedure

INFOID:000000012431249

1. CHECK BATTERY TERMINALS CONNECTION

Check if battery terminals are clean and tight.

Is the inspection result normal?

YES >> GO TO 2.

NO >> Repair battery terminal connection. Confirm repair by performing complete Charging system test using EXP-800 NI or GR8-1200 NI (if available). Refer to the applicable Instruction Manual for proper testing procedures.

2. CHECK FUSE

Check for blown fuse and fusible link.

Unit	Power source (Power supply terminals)	Fuse or Fusible Link
Generator	Battery (terminal 3)	Fuse 24
	Battery (terminal 1)	Fusible Link A
Combination meter	Ignition switch ON (terminal 28)	Fuse 3

Is the inspection result normal?

YES >> GO TO 3.

NO >> Replace the blown fuse or fusible link after repairing the affected circuit.

3. CHECK GENERATOR GROUND TERMINAL CONNECTION

Check if connector F4 terminal 5 is clean.

Is the inspection result normal?

YES >> GO TO 4.

NO >> Repair connection.

4. CHECK DRIVE BELT TENSION

Check drive belt tension. Refer to [EM-17, "Adjustment"](#).

Is the inspection result normal?

YES >> Inspection End.

NO >> Repair as needed.

POWER GENERATION VOLTAGE VARIABLE CONTROL SYSTEM OPERATION INSPECTION

< DTC/CIRCUIT DIAGNOSIS >

POWER GENERATION VOLTAGE VARIABLE CONTROL SYSTEM OPERATION INSPECTION

Diagnosis Procedure

INFOID:000000012431250

Regarding Wiring Diagram information. Refer to [CHG-9. "Wiring Diagram"](#).

CAUTION:

When performing this inspection, always use a charged battery that has completed the battery inspection. (When the charging rate of the battery is low, the response speed of the voltage change will become slow. This can cause an incorrect inspection.)

1. CHECK ECM (CONSULT)

Perform "Self Diagnostic Result" of "ECM" with CONSULT. Refer to [EC-60. "CONSULT Function"](#).

Self-diagnostic results content

No malfunction detected>> GO TO 2.

Malfunction detected>> Check applicable parts, and repair or replace corresponding parts.

2. CHECK OPERATION OF POWER GENERATION VOLTAGE VARIABLE CONTROL SYSTEM

1. Connect CONSULT and start the engine.
2. The selector lever is in "P" or "N" position and all of the electric loads and A/C, etc. are turned OFF.
3. Select "ALTERNATOR DUTY" in "Active Test" of "ENGINE", and then check the value of "BATTERY VOLT" monitor when DUTY value of "DUTY" is set to 40.0 %.

"BATTERY VOLT"

2 seconds after setting the DUTY value of "ALTERNATOR DUTY" to 40.0 % : 12 - 13.6 V

4. Check the value of "BATTERY VOLT" monitor when DUTY value of "DUTY" is set to 80.0%.

"BATTERY VOLT"

20 seconds after setting the DUTY value of "ALTERNATOR DUTY" to 80.0 % : +0.5 V or more against the value of "BATTERY VOLT" monitor when DUTY value is 40.0 %

Is the inspection result normal?

YES >> Inspection End.

NO >> GO TO 3.

3. CHECK IPDM E/R (CONSULT)

Perform "Self Diagnostic Result" of "IPDM E/R" with CONSULT. Refer to [PCS-10. "CONSULT Function \(IPDM E/R\)"](#).

Is the inspection result normal?

No malfunction detected>> GO TO 4.

Malfunction detected>> Check applicable parts, and repair or replace corresponding parts.

4. CHECK HARNESS BETWEEN GENERATOR AND IPDM E/R

1. Turn ignition switch OFF.
2. Disconnect generator connector and IPDM E/R connector.
3. Check continuity between generator harness connector and IPDM E/R harness connector.

A
B
C
D
E
F
G
H
I
J
K
L
N
O
P

CHG

POWER GENERATION VOLTAGE VARIABLE CONTROL SYSTEM OPERATION INSPECTION

< DTC/CIRCUIT DIAGNOSIS >

Generator		IPDM E/R		Continuity
Connector	Terminal	Connector	Terminal	
F1	4	F43	48	Yes

4. Check continuity between generator harness connector and ground.

Generator		—	Continuity
Connector	Terminal		
F1	4	Ground	No

Is the inspection result normal?

- YES >> Replace IPDM E/R. Refer to [PCS-30, "Removal and Installation"](#).
- NO >> Repair harness or connectors between IPDM E/R and generator.

B TERMINAL CIRCUIT

< DTC/CIRCUIT DIAGNOSIS >

B TERMINAL CIRCUIT

Description

INFOID:0000000012431251

"B" terminal circuit supplies power to charge the battery and to operate the vehicles electrical system.

Diagnosis Procedure

INFOID:0000000012431252

Regarding Wiring Diagram information. Refer to [CHG-9, "Wiring Diagram"](#).

1.CHECK "B" TERMINAL CONNECTION

1. Turn ignition switch OFF.
2. Check if "B" terminal is clean and tight.

Is the inspection result normal?

YES >> GO TO 2.

NO >> Repair terminal "B" connection. Confirm repair by performing complete Charging system test using the EXP-800 NI or GR8-1200 NI (if available). Refer to applicable Instruction Manual for proper testing procedures.

2.CHECK "B" TERMINAL CIRCUIT

Check voltage between generator "B" terminal and ground.

(+)		(-)	Voltage (Approx.)
Generator			
Connector	Terminal		
F2	1	Ground	Battery voltage

Is the inspection result normal?

YES >> GO TO 3.

NO >> Check harness for open between generator and fusible link.

3.CHECK "B" TERMINAL CONNECTION (VOLTAGE DROP TEST)

1. Start engine, then engine running at idle and warm.
2. Check voltage between battery positive terminal and generator connector "B" terminal.

(+)		(-)	Voltage (Approx.)
Generator			
Connector	Terminal		
F2	1	Battery positive terminal	Less than 0.2V

Is the inspection result normal?

YES >> "B" terminal circuit is normal. Refer to [CHG-14, "Work Flow \(With EXP-800 NI or GR8-1200 NI\)"](#) or [CHG-17, "Work Flow \(Without EXP-800 NI or GR8-1200 NI\)"](#).

NO >> Check harness between battery and generator for continuity.

L TERMINAL CIRCUIT (OPEN)

< DTC/CIRCUIT DIAGNOSIS >

L TERMINAL CIRCUIT (OPEN)

Description

INFOID:000000012431253

The "L" terminal circuit controls the charge warning lamp. The charge warning lamp turns ON when the ignition switch is set to ON or START. When the generator is providing sufficient voltage with the engine running, the charge warning lamp turns OFF. If the charge warning lamp illuminates with the engine running, a malfunction is indicated.

Diagnosis Procedure

INFOID:000000012431254

Regarding Wiring Diagram information. Refer to [CHG-9, "Wiring Diagram"](#).

1. CHECK "L" TERMINAL CONNECTION

1. Turn ignition switch OFF.
2. Check if "L" terminal is clean and tight.

Is the inspection result normal?

YES >> GO TO 2.

NO >> Repair "L" terminal connection. Confirm repair by performing complete Charging system test using EXP-800 NI or GR8-1200 NI (if available). Refer to applicable Instruction Manual for proper testing procedures.

2. CHECK "L" TERMINAL CIRCUIT (OPEN)

1. Disconnect the generator connector.
2. Apply ground to generator harness connector terminal.
3. Check condition of the charge warning lamp with the ignition switch in the ON position.

Generator		Ground	Condition	
Connector	Terminal		Ignition switch position	Charge warning lamp
F1	2		ON	Illuminate

Does it illuminate?

YES >> "L" terminal circuit is normal. Refer to [CHG-14, "Work Flow \(With EXP-800 NI or GR8-1200 NI\)"](#) or [CHG-17, "Work Flow \(Without EXP-800 NI or GR8-1200 NI\)"](#).

NO >> GO TO 3.

3. CHECK HARNESS CONTINUITY (OPEN CIRCUIT)

1. Disconnect the battery cable from the negative terminal.
2. Disconnect the combination meter connector.
3. Check continuity between generator harness connector and combination meter harness connector.

Generator		Combination meter		Continuity
Connector	Terminal	Connector	Terminal	
F1	2	M82 (Type A)	38	Yes
		M24 (Type B)		

is the inspection result normal?

YES >> GO TO 4.

NO >> Repair or replace the harness or connectors.

4. CHECK POWER SUPPLY CIRCUIT

1. Connect the battery cable to the negative terminal.
2. Check voltage between combination meter harness connector and ground.

L TERMINAL CIRCUIT (OPEN)

< DTC/CIRCUIT DIAGNOSIS >

(+)		(-)	Condition	Voltage (Approx.)
Combination meter				
Connector	Terminal			
M82 (type A)	28	Ground	When the ignition switch is in ON position	Battery voltage
M24 (type B)				

Is the inspection result normal?

- YES >> Replace the combination meter. Refer to [MWI-54. "Removal and Installation"](#) (Type A) or [MWI-115. "Removal and Installation"](#) (Type B).
- NO >> Repair or replace the harness or connectors.

A
B
C
D
E
F
G
H
I
J
K
L
N
O
P

CHG

L TERMINAL CIRCUIT (SHORT)

< DTC/CIRCUIT DIAGNOSIS >

L TERMINAL CIRCUIT (SHORT)

Description

INFOID:000000012431255

The terminal "L" circuit controls the charge warning lamp. The charge warning lamp turns ON when the ignition switch is set to ON or START. When the generator is providing sufficient voltage with the engine running, the charge warning lamp turns off. If the charge warning lamp illuminates with the engine running, a malfunction is indicated.

Diagnosis Procedure

INFOID:000000012431256

Regarding Wiring Diagram information, refer to [CHG-9, "Wiring Diagram"](#).

1. CHECK "L" TERMINAL CIRCUIT (SHORT)

1. Turn ignition switch OFF.
2. Disconnect generator connector.
3. Turn ignition switch ON.

Does charge warning lamp illuminate?

YES >> GO TO 2.

NO >> Refer to [CHG-14, "Work Flow \(With EXP-800 NI or GR8-1200 NI\)"](#) or [CHG-17, "Work Flow \(Without EXP-800 NI or GR8-1200 NI\)"](#).

2. CHECK HARNESS CONTINUITY (SHORT CIRCUIT)

1. Turn ignition switch OFF.
2. Disconnect the battery cable from the negative terminal.
3. Disconnect combination meter connector.
4. Check continuity between the combination meter harness connector and ground.

Combination meter		Ground	Continuity
Connector	Terminal		
M82 (type A)	38		No
M24 (type B)			

Is the inspection result normal?

YES >> Replace the combination meter. Refer to [MWI-54, "Removal and Installation"](#) (Type A) or [MWI-115, "Removal and Installation"](#) (Type B).

NO >> Repair or replace the harness or connectors.

S TERMINAL CIRCUIT

< DTC/CIRCUIT DIAGNOSIS >

S TERMINAL CIRCUIT

Description

INFOID:0000000012431257

The output voltage of the generator is controlled by the IC regulator at terminal "S" detecting the input voltage from battery.
The "S" terminal circuit detects the battery voltage to adjust the generator output voltage with the IC voltage regulator.

Diagnosis Procedure

INFOID:0000000012431258

Regarding Wiring Diagram information. Refer to [CHG-9, "Wiring Diagram"](#).

1. CHECK "S" TERMINAL CONNECTION

1. Turn ignition switch OFF.
2. Check if "S" terminal is clean and tight.

Is the inspection result normal?

YES >> GO TO 2.

NO >> Repair "S" terminal connection. Confirm repair by performing complete Charging system test using EXP-800 NI or GR8-1200 NI (if available). Refer to the applicable Instruction Manual for proper testing procedures.

2. CHECK "S" TERMINAL CIRCUIT

Check voltage between generator harness connector and ground.

(+) Generator		(-)	Voltage (Approx.)
Connector	Terminal		
F1	3	Ground	Battery voltage

Is the inspection result normal?

YES >> Refer to [CHG-14, "Work Flow \(With EXP-800 NI or GR8-1200 NI\)"](#) or [CHG-17, "Work Flow \(Without EXP-800 NI or GR8-1200 NI\)"](#).

NO >> Check harness for open between generator and fuse.

A
B
C
D
E
F
G
H
I
J
K
L
N
O
P

CHG

CHARGING SYSTEM

< SYMPTOM DIAGNOSIS >

SYMPTOM DIAGNOSIS

CHARGING SYSTEM

Symptom Table

INFOID:000000012431259

Symptom	Reference
Battery discharged	Refer to CHG-14, "Work Flow (With EXP-800 NI or GR8-1200 NI)" or CHG-17, "Work Flow (Without EXP-800 NI or GR8-1200 NI)" .
The charge warning lamp does not illuminate when the ignition switch is set to ON.	
The charge warning lamp does not turn OFF after the engine starts.	
The charging warning lamp turns ON when increasing the engine speed.	

GENERATOR

< REMOVAL AND INSTALLATION >

REMOVAL AND INSTALLATION

GENERATOR

Exploded View

INFOID:0000000012431260

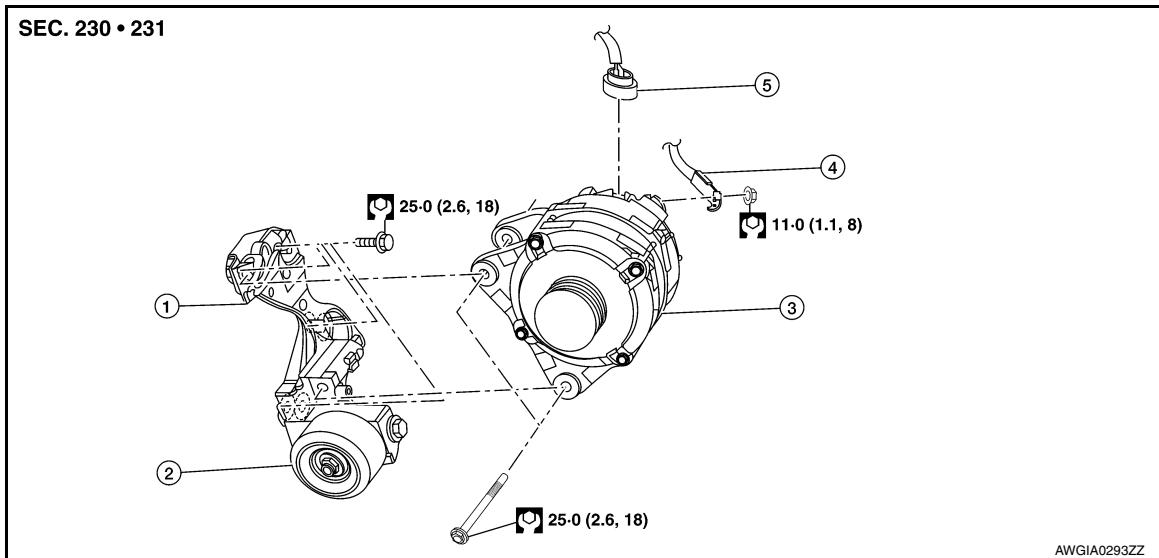

- | | | |
|-------------------------|--------------------------------|--------------|
| 1. Generator bracket | 2. Tensioner Idler pulley | 3. Generator |
| 4. "B" terminal harness | 5. Generator harness connector | |

Removal and Installation

INFOID:0000000012431261

REMOVAL

1. Disconnect the battery cable from the negative terminal. Refer to [PG-70, "Exploded View"](#).
2. Remove the radiator core support upper. Refer to [DLK-144, "RADIATOR CORE SUPPORT UPPER : Removal and Installation"](#) (with intelligent key system) or [DLK-272, "RADIATOR CORE SUPPORT UPPER : Removal and Installation"](#) (without intelligent key system).
3. Remove drive belt. Refer to [EM-24, "Exploded View"](#).
4. Disconnect the harness connector from generator.
5. Remove "B" terminal nut and disconnect "B" terminal harness.
6. Remove the generator bolts.
7. Remove the generator.
CAUTION:
Do not damage surrounding parts when removing generator from the vehicle.
8. Remove bolts and remove generator bracket (if necessary).

INSTALLATION

A
B
C
D
E
F
G
H
I
J
K
L
N
O
P

CHG

GENERATOR

< REMOVAL AND INSTALLATION >

1. Install the generator bracket (if removed) using the following procedure:
 - a. Temporarily tighten bolts.
 - b. Tighten bolts to specification in numerical order as shown.

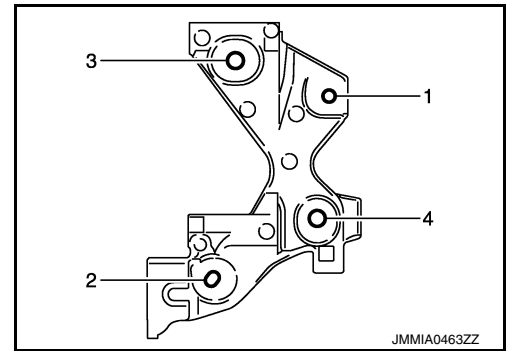

2. Install the generator using the following procedure:
 - a. Temporarily tighten the generator bolts in order from the lower to the upper.
 - b. Tighten the generator bolts to the specification starting with the top bolt.
 - c. Install "B" terminal harness and "B" terminal nut.
CAUTION:
Be sure to tighten "B" terminal nut carefully.
3. Installation of the remaining components is in the reverse order of removal.

SERVICE DATA AND SPECIFICATIONS (SDS)

< SERVICE DATA AND SPECIFICATIONS (SDS)

SERVICE DATA AND SPECIFICATIONS (SDS)

SERVICE DATA AND SPECIFICATIONS (SDS)

Generator

INFOID:0000000012431262

Model*	A002TJ1791ZX
Manufacturer	Mitsubishi
Nominal rating	13.5V - 110A
Ground polarity	Negative
Minimum revolution under no-load	1,000 rpm
Hot output current (When 13.5 V is applied)	More than 27A/1,300 rpm More than 95A/2,500 rpm More than 116A/5,000 rpm
Regulated output voltage	14.1 - 14.7V @20°C (68°F)
Adjustment range of power generation voltage variable control	11.4 - 15.6V

* : Always check with the Parts Department for the latest parts information.

A
B
C
D
E
F
G
H
I
J
K
L
N
O
P

CHG